

COMMAND LIGHT

ELEVATE YOUR SCENE LIGHTING

SEE THE DIFFERENCE
A LIGHT TOWER MAKES



PERIMETER LIGHTING

VS

COMMAND LIGHT TOWERS

OUR DIFFERENCE.

DEPLOYMENT

- ✓ Feature a patented (US Patent #5303621) movement, allowing endless positions
- ✓ Can overhang the side of a vehicle in Command Light's exclusive streetlight position
- ✓ Deploys fully in less than 15 seconds with the press of a button
- ✓ Stows quickly with a one-touch auto-park feature

DURABILITY

- ✓ 100% electric, meaning no air or hydraulics
- ✓ Virtually maintenance free and operable in ALL weather conditions
- ✓ NFPA 1901 compliant and tested to winds up to 90 mph
- ✓ Built with aircraft-grade aluminum alloy to add strength while reducing weight

INDUSTRY-LEADING 5-YEAR WARRANTY

Command Light products come with an industry-leading, five-year warranty against any defects in materials and workmanship when used and operated for a period of five years. Excludes malfunctions related to misuse, accident, neglect or normal wear-and-tear, as well as light-producing components (bulbs, lasers, LEDs), which come with their own manufacturer's warranty.

LIGHT TOWERS

VS TRUCK-MOUNTED PERIMETER LIGHTS

COMMAND LIGHT
CL602R-W2 WITH BACKLIGHT



PERIMETER LIGHTS
1 WHELEN 900 SERIES AND 2 WHELEN M95 ON EACH SIDE OF THE TRUCK

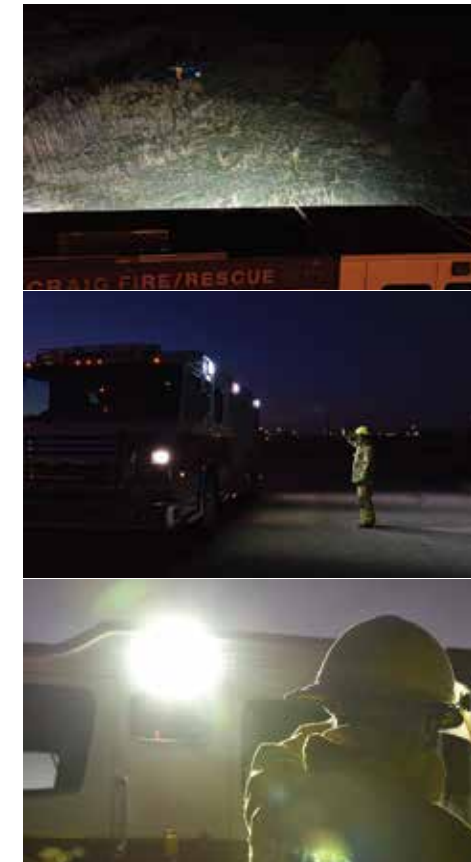

PERIMETER LIGHTS
1 WHELEN M9 AND 2 FIRETECH FT-B-45 (46" LED STICKS) ON EACH SIDE OF THE TRUCK



With new LEDs on the market, it's tempting to equip trucks with only corner light fixtures, but don't be fooled. This Command Light illumination comparison shows how truck-mounted perimeter LEDs stack up against a light tower. With corner-mounted LEDs, only HALF of the light output is directed at the scene, and this eye-level light creates glare for crews. Meanwhile, Command Light's patented movement clusters ALL of your fixtures, allowing light to gather and be directed for maximum output, much like sport stadium lights. The difference is night and day.

SEE THE FULL STUDY AT WWW.COMMANDLIGHT.COM/WHY-LIGHT-TOWERS

THREE WAYS YOU CAN
DIRECT LIGHT
WITH A LIGHT TOWER



360° ROTATION



STREETLAMP POSITION



OPTIONAL BACKLIGHT

COMMAND LIGHT

WHICH TOWER IS RIGHT FOR YOU?

Command Light specializes in emergency scene lighting, offering a patented light tower design that has been trusted for decades. To help you navigate Command Light's broad lineup, this catalog is organized by tower height (ie. Series), number of heads, power requirements and optional features.

1 SELECT THE IDEAL HEIGHT

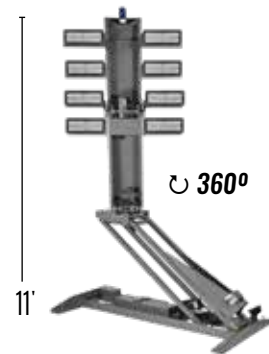

CL SERIES
LARGEST REACH
Pages 8-11



KNIGHT SERIES
MID-SIZE HEIGHT
Pages 12-15



SHADOW SERIES
SHORTEST TOWER
Pages 16-19



C-LITE
COMPACT LIGHTING
Page 20

CHOOSE YOUR FIXTURE/POWER CONFIGURATION



2 # OF HEADS
CHOOSE FROM 2, 4, 6 OR 8

The number of heads will determine how much light you can gather and direct using rotation, angling and optional backlight.

- 8 HEAD Page 9
- 6 HEAD Pages 9-11, 13
- 4 HEAD Pages 9-11, 14, 17
- 2 HEAD Pages 18-20



3 POWER
AC OR DC

Do you need an AC (115/230V) powered unit or DC (12V or 24V) power? Look for the **AC** and **DC** chart labels to help you pinpoint the right towers.

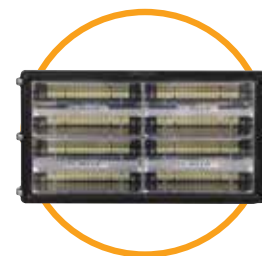

4 LIGHT FIXTURES
LED OR QUARTZ HALOGEN

Looking for LEDs (long-lasting lamps at a lower power draw, or quartz halogen (bright fixtures for less cost)? Refer to the **LEDs** and **QUARTZ HALOGEN** labels.

MORE INFO Pages 6-7

For Traffic Flow Boards, please see Pages 22-23

ADD OPTIONAL FEATURES

5 UPGRADES



BACKLIGHT

Command Light's backlight option enables the bottom row of lamp heads to rotate 180°, making it possible to light both sides of the scene.



TOP-MOUNTED STROBE

Alert oncoming traffic earlier with a strobe mounted on top of the light tower. Available in green, red, amber, blue or clear.



LONG ARM

Get an additional 2' or 4' of reach with a 65" or 80" long arm.



CUSTOM COLORS

Optional colors include powder-coated white, red and black. Towers can be wet painted to any color. (Standard: Powder-coated gray.)

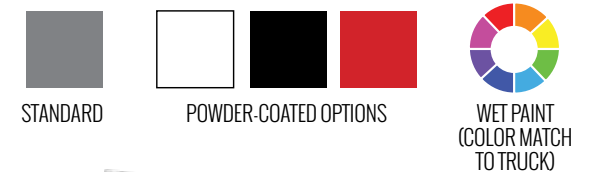

TOP-MOUNTED CAMERA

A top-mounted camera provides additional 360° views for apparatus operators, helping keep personnel safe on the fire ground. Choose from the INTEC, Safety Vision or Zone Defense video systems. Learn more about these cameras at commandlight.com/360-vehicle-cameras.



CONTROL OPTIONS



STANDARD

The Standard Controller comes with a 15 ft (4.5 m) umbilical cord and intuitive buttons, giving crews the ability to control every aspect of the tower and lights.



WIRELESS

Available on any Command Light tower, this optional Wireless Controller has a range of up to 150 ft (45 m) and supplements the Standard Controller.



PANEL-MOUNTED

This Panel-Mounted Controller can be added to a compartment or any protected area. Available on all towers, this option can be used alone or with another controller.











V-MUX / CLASS 1

Operate your light tower via V-Mux or Class 1 in-cab controls, which supplements the standard controller and is available on all Command Light towers.





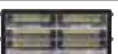

*** All fixtures specifications are provided by the manufacturer and are subject to change; all information is the latest available at the time of publication.

LEDs

LEDs produce long-lasting, energy-efficient lighting by passing a current through a semi-conductor rich in electrons and a semi-conductor rich in holes to produce photons, the light you see.

AC	LEDs	POWER	TOTAL WATTS	OUTPUT
HELIOS*	 Exclusive Command Light fixture that delivers an economical LED!	115V or 230V AC	60w	14,000 lumens
FRC SPECTRA	 Spot/flood combination	115V or 230V AC	220w	20,000 lumens
FRC SPECTRA MAX**	 Top/bottom flood lights with middle spot LED and lower diffuser	115V or 230V AC	335w	28,000 lumens
FIRETECH HIVIZ	 Knight Slim exclusive, featuring two 270-watt and two 60-watt fixtures	115V AC	60w 270w	6,500 lumens 28,500 lumens
WHELEN PIONEER PLUS PCP2***	 Spot/flood combination	115V or 230V AC	150w	20,614 lumens
WHELEN PIONEER PLUS PFP2	 Dual panel with flood light	115V or 230V AC	150w	20,442 lumens
WHELEN PIONEER PLUS PFP4	 Quad panel with flood light and Whelen's highest luminous output	115V or 230V AC	300w	40,884 lumens
WHELEN PIONEER PLUS PSP1	 Single panel with spot light	115V or 230V AC	75w	8,517 lumens



*An exclusive Command Light fixture, manufactured by FireTech. **FRC Spectra Max-S are also available upon request. *** Upgrade from standard Whelen flood to spot/flood combo upon request.

DC	LEDs	POWER	TOTAL WATTS	OUTPUT
HELIOS*	 Exclusive Command Light fixture that delivers an economical LED!	12V or 24V DC	60w	14,000 lumens
FRC EVOLUTION	 Parabolic reflector that illuminates action and working area	12V or 24V DC	160w	20,000 lumens
FRC SPECTRA	 Uniform flood and spot combination of super bright, white light	12V or 24V DC	220w	20,000 lumens
FRC SPECTRA MAX**	 Top/bottom flood lights with middle spot LED and lower diffuser	12V or 24V DC	230w	28,000 lumens
FIRETECH HIVIZ	 Knight Slim exclusive, featuring two 270-watt and two 60-watt fixtures	12V or 24V DC	60w 270w	6,500 lumens 28,500 lumens
FIRETECH SL-X-15****	 More output with less power consumption	12V or 24V DC	185w	15,306 lumens
LIGHTFORCE HTX	 Combines 20 LEDs for flood beam - HID bulb for 1,932 yards of viewing	12V or 24V DC	150w	13,500 lumens
WHELEN PIONEER PLUS PCH1	 Single panel with combo flood/spot and Proclera® silicone optics	12V or 24V DC	75w	10,130 lumens
WHELEN PIONEER PLUS PCH2***	 Spot/flood combination	12V or 24V DC	150w	20,261 lumens
WHELEN PIONEER PLUS PFH2	 Dual panel with combo flood/spot and Proclera® silicone optics	12V or 24V DC	150w	20,261 lumens

*An exclusive Command Light fixture, manufactured by FireTech. **FRC Spectra Max-S are also available upon request. *** Upgrade from standard Whelen flood to spot/flood combo upon request. ****Available upon request.

QUARTZ HALOGEN

The quartz halogen bulb is a type of incandescent bulb that has been refined to produce more light per unit of energy. The filament tube has a small amount of halogen gas in it to prevent bulb darkening and filament evaporation, which increases the bulb life while producing crisp light.

AC	QUARTZ HALOGEN	POWER	TOTAL WATTS	OUTPUT
HUBBELL QUARTZLITER	 Full fixture that runs at or below rated temperature for 2,000-hour life	115V or 230V AC	500w 750w 1,000w 1,500w	11,100 lumens 16,500 lumens 21,500 lumens 35,800 lumens
FRC FOCUS	 Reflector redirects and focuses light	115V or 230V AC	750w	19,600 lumens
LUMENFORM	 Industrial-grade quartz halogen luminary	115V or 230V AC	500w	11,100 lumens

LED RETROFITS

Lengthen the lifespan of your quartz halogen tower by converting it to LED!

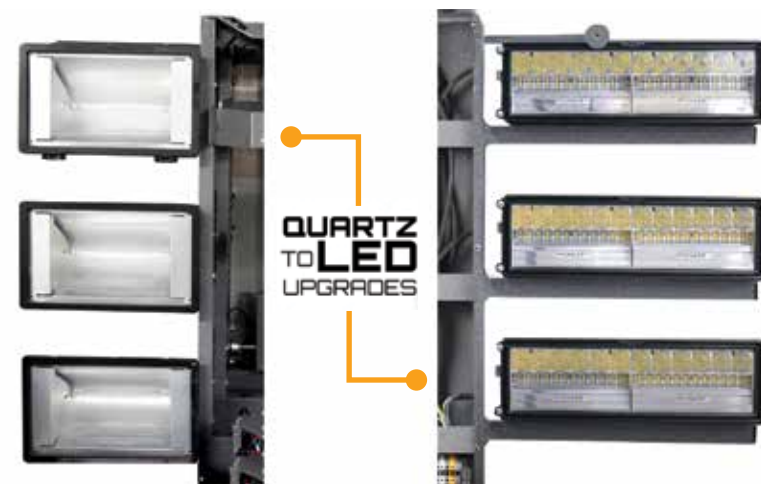

- ✓ Retrofit most in-service quartz halogen 2-, 4- and 6-head towers
- ✓ Update to the latest LED technology from FRC, Whelen and Command Light's very own retrofit fixture, the Helios
- ✓ With just your Command Light serial number, we can determine if your tower can be upgraded
- ✓ Cost varies based on fixture selection, complexity of upgrade and the number of heads

SLs and KLs include new lamp trees; CLs include new lamp brackets. Note: Upgrade pricing is not valid on towers less than 1 year old.



See before-and-after footage of a Command Light LED retrofit at bit.ly/led-retrofit.

CL SERIES

TOWERS WITH 11-FOOT REACH

CL SERIES



THE CL SERIES OCTOLIGHT Meet the industry's most powerful light tower, the CL Series Octolight eight-head tower, available with FRC or Whelen fixtures. The Whelen Pioneer Plus PFP4 fixtures provide a whopping 327,072 luminous output, while the FRC Spectra Max heads deliver combo optics with top-and-bottom flood lights, plus middle-spot LEDs for long-distance illumination.

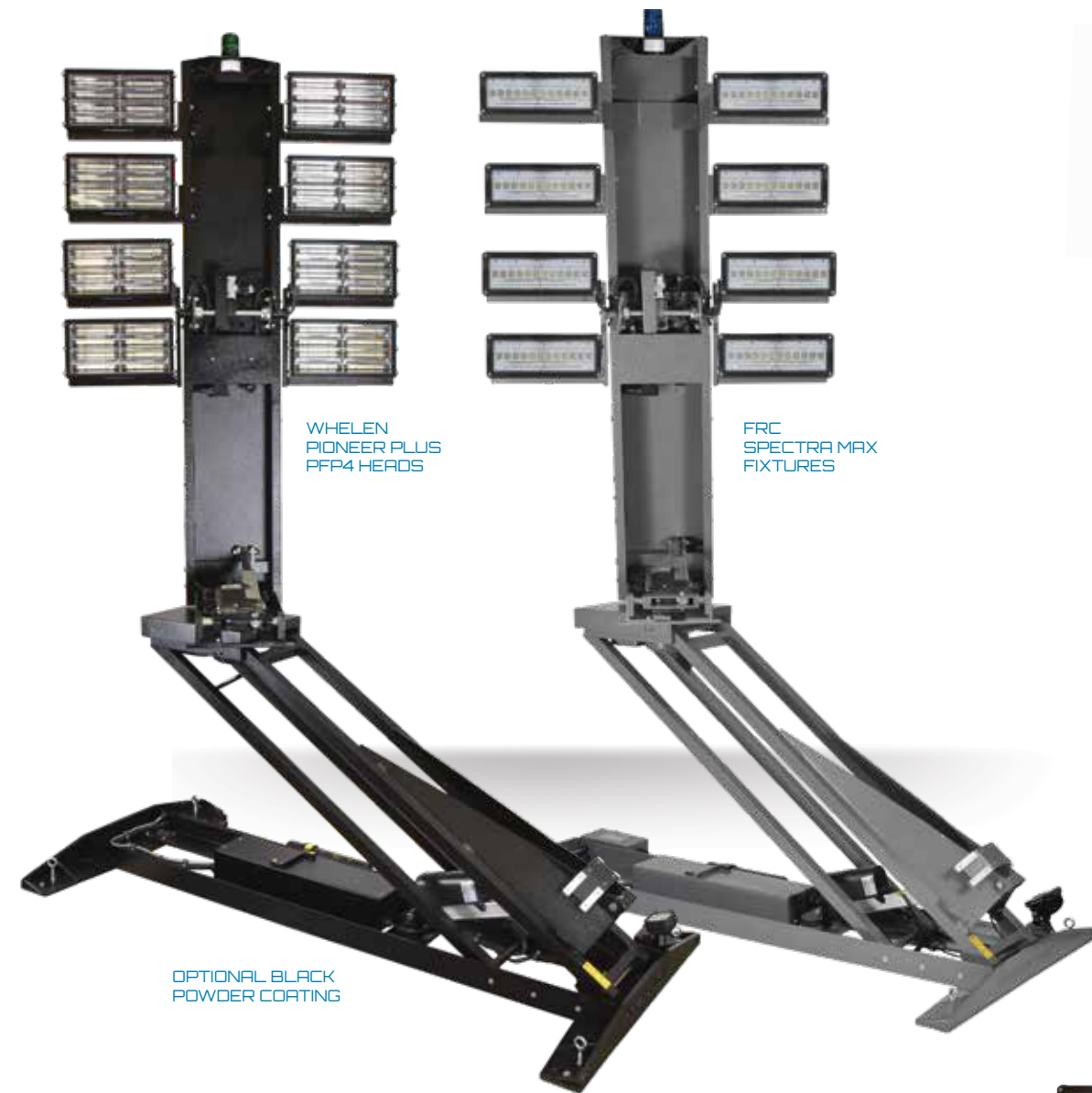

NESTED POSITION

OPTIONS
(SEE PAGE 5 FOR DESCRIPTIONS)



BACKLIGHT



STROBE



COLOR



CAMERA



CONTROLS

OPTIONAL BLACK POWDER COATING



FRC Spectra Max

Whelen Pioneer Plus PFP4

LEDs

THE CL SERIES towers are Command Light's largest units with a reach up to 11 feet from its base. These units are designed for large apparatus and are manufactured using aircraft-grade aluminum alloy to reduce weight while adding strength. These towers can rotate 360° and tilt, raise and lower with ease to mitigate shadows in all types of situations. Unlike truck-mounted perimeter LEDs, this gives crews the ability to direct all of the usable light. A tower can even be angled to overhang the vehicle to provide operable light near the side of the apparatus.

AC	LIGHTING	POWER REQUIREMENTS	OUTPUT (PER LIGHT)	TOTAL OUTPUT	HXWXD (NESTED)	HXWXD (UPRIGHT)	WT.
CL802A-FX	FRC Spectra Max 335w	115V or 230V AC 2,980w	28,000 lumens	224,000 lumens	12" x 74" x 43" 305 mm x 1,880 mm x 1,095 mm	131" x 79" x 43" 3,330 mm x 2,010 mm x 1,095 mm	325 lbs 147 kg
CL802A-W4	Whelen Pioneer Plus PFP4 300w	115V or 230V AC 2,700w	40,884 lumens	327,072 lumens	12" x 74" x 43" 305 mm x 1,880 mm x 1,095 mm	131" x 79" x 43" 3,330 mm x 2,010 mm x 1,095 mm	325 lbs 147 kg



CL SERIES LIGHT TOWERS With an 11-foot reach, the CL Series light tower has the ability to provide even lighting across large scenes and reach over (and beyond) obstacles. These towers concentrate and precisely direct the light source, reducing shadows and intense ground-level light. The CL Series also has the ability to direct light at higher levels, aiding in mountain slope and high-rise building rescues.

OPTIONS (SEE PAGE 5 FOR DESCRIPTIONS)



LEDs

AC	LIGHTING	POWER REQUIREMENTS	OUTPUT (PER LIGHT)	TOTAL OUTPUT	HxWxD (NESTED)	HxWxD (UPRIGHT)	WT.
CL602A-FS	FRC Spectra 220w	115V or 230V AC 1,750w	20,000 lumens	120,000 lumens	12" x 74" x 43" 305 mm x 1,880 mm x 1,095 mm	131" x 79" x 43" 3,330 mm x 2,010 mm x 1,095 mm	305 lbs 139 kg
CL602A-FX	FRC Spectra Max 335w	115V or 230V AC 2,440w	28,000 lumens	168,000 lumens	12" x 74" x 43" 305 mm x 1,880 mm x 1,095 mm	131" x 79" x 43" 3,330 mm x 2,010 mm x 1,095 mm	
CL602A-W2	Whelen Pioneer Plus PFP2 150w	115V or 230V AC 1,350w	20,442 lumens	122,652 lumens	12" x 74" x 43" 305 mm x 1,880 mm x 1,095 mm	131" x 79" x 43" 3,330 mm x 2,010 mm x 1,095 mm	
CL602A-W4	Whelen Pioneer Plus PFP4 300w	115V or 230V AC 2,250w	40,884 lumens	245,304 lumens	12" x 74" x 43" 305 mm x 1,880 mm x 1,095 mm	131" x 79" x 43" 3,330 mm x 2,010 mm x 1,095 mm	

QUARTZ HALOGEN

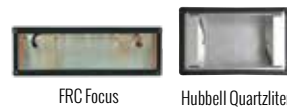

AC	LIGHTING	POWER REQUIREMENTS	OUTPUT (PER LIGHT)	TOTAL OUTPUT	HxWxD (NESTED)	HxWxD (UPRIGHT)	WT.
CL607A-FF	FRC Focus 750w	115V or 230V AC 4,800w	19,600 lumens	117,600 lumens	12" x 74" x 41" 305 mm x 1,880 mm x 1,041 mm	131" x 79" x 41" 3,330 mm x 2,010 mm x 1,041 mm	305 lbs 139 kg
CL605A-HQ	Hubbell Quartzlizer 500w	115V or 230V AC 3,300w	11,100 lumens	66,600 lumens	12" x 74" x 42" 305 mm x 1,880 mm x 1,065 mm	131" x 79" x 42" 3,330 mm x 2,010 mm x 1,065 mm	
CL607A-HQ	Hubbell Quartzlizer 750w	115V or 230V AC 4,800w	16,500 lumens	99,000 lumens	12" x 74" x 42" 305 mm x 1,880 mm x 1,065 mm	131" x 79" x 42" 3,330 mm x 2,010 mm x 1,065 mm	
CL611A-HQ	Hubbell Quartzlizer 1,000w	230V AC 6,300w	21,500 lumens	129,000 lumens	12" x 74" x 42" 305 mm x 1,880 mm x 1,065 mm	131" x 79" x 42" 3,330 mm x 2,010 mm x 1,065 mm	
CL615A-HQ	Hubbell Quartzlizer 1,500w	230V AC 9,300w	20,261 lumens	81,044 lumens	12" x 74" x 42" 305 mm x 1,880 mm x 1,065 mm	131" x 79" x 42" 3,330 mm x 2,010 mm x 1,065 mm	



QUESTIONS? CUSTOM TOWER INQUIRIES?
CONTACT US AT INFO@COMMANDLIGHT.COM.

OPTIONS (SEE PAGE 5 FOR DESCRIPTIONS)



* On this DC tower, amperage only allows for one of these options.

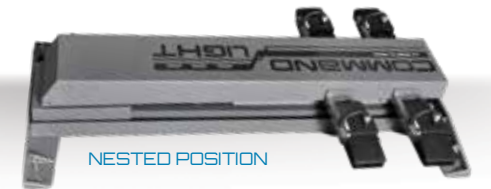

LEDs



DC	LIGHTING	POWER REQUIREMENTS	OUTPUT (PER LIGHT)	TOTAL OUTPUT	HxWxD (NESTED)	HxWxD (UPRIGHT)	WT.
CL602D-FE	FRC Evolution 160w	12V DC - 67 amps 800w	20,000 lumens	80,000 lumens	12" x 74" x 41" 305 mm x 1,880 mm x 1,041 mm	131" x 79" x 41" 3,330 mm x 2,010 mm x 1,041 mm	305 lbs 139 kg
CL602D-FS	FRC Spectra 220w	12V DC - 88 amps 1,050w	20,000 lumens	80,000 lumens	12" x 74" x 43" 305 mm x 1,880 mm x 1,095 mm	131" x 79" x 43" 3,330 mm x 2,010 mm x 1,095 mm	
CL602D-FX	FRC Spectra Max 230w	12V DC - 100 amps 1,200w	28,000 lumens	168,000 lumens	12" x 74" x 43" 305 mm x 1,880 mm x 1,095 mm	131" x 79" x 43" 3,330 mm x 2,010 mm x 1,095 mm	
CL602D-W2	Whelen Pioneer Plus PFH2 150w	12V DC - 63 amps 600w	18,520 lumens	74,080 lumens	12" x 74" x 43" 305 mm x 1,880 mm x 1,095 mm	131" x 79" x 43" 3,330 mm x 2,010 mm x 1,095 mm	

KL SERIES

TOWERS WITH 7.5-FOOT REACH

THE KNIGHT SERIES. Command Light's mid-size tower, delivers a reach of nearly 7.5 feet from its base. Like the CL Series, these units are manufactured using aircraft-grade aluminum but are roughly half the weight of their taller counterpart, making these towers ideal for apparatus with limited space. The series also includes the KL Slim, a narrow tower with a small 53" x 13" footprint, perfect for tight dunnage areas or high-side aerial compartments.



NESTED POSITION

KL SERIES



LEDs

AC	LIGHTING	POWER REQUIREMENTS	OUTPUT (PER LIGHT)	TOTAL OUTPUT	HXWXD (NESTED)	HXWXD (UPRIGHT)	WT.
KL415A-CH	Helios 60w	115V or 230V AC 660w	14,000 lumens	84,000 lumens	12" x 47" x 34" 305 mm x 1,195 mm x 865 mm	87.5" x 52" x 34" 2,225 mm x 1,320 mm x 865 mm	165 lbs 75 kg
KL415A-FS	FRC Spectra 220w	115V or 230V AC 1,620w	20,000 lumens	120,000 lumens	12" x 47" x 34" 305 mm x 1,195 mm x 865 mm	87.5" x 52" x 34" 2,225 mm x 1,320 mm x 865 mm	
KL415A-FX	FRC Spectra Max 335w	115V or 230V AC 2,310w	28,000 lumens	168,000 lumens	12" x 47" x 34" 305 mm x 1,195 mm x 865 mm	87.5" x 52" x 34" 2,225 mm x 1,320 mm x 865 mm	
KL415A-W2	Whelen Pioneer Plus PFP2 150w	115V or 230V AC 1,200w	20,442 lumens	122,652 lumens	12" x 47" x 34" 305 mm x 1,195 mm x 865 mm	87.5" x 52" x 34" 2,225 mm x 1,320 mm x 865 mm	
KL408A-W1	Whelen Pioneer Plus PSP1 75w	115V or 230V AC 750w	8,517 lumens	51,102 lumens	14" x 47" x 23" 355 mm x 1,195 mm x 584 mm	87.5" x 52" x 23" 2,225 mm x 1,320 mm x 584 mm	
DC	LIGHTING	POWER REQUIREMENTS	OUTPUT (PER LIGHT)	TOTAL OUTPUT	HXWXD (NESTED)	HXWXD (UPRIGHT)	WT.
KL415D-CH	Helios 60w	12V DC - 55 amps 660w	14,000 lumens	84,000 lumens	12" x 47" x 34" 305 mm x 1,195 mm x 865 mm	87.5" x 52" x 34" 2,225 mm x 1,320 mm x 865 mm	165 lbs 75 kg
KL408D-W1	Whelen Pioneer Plus PCH1 75w	12V DC - 63 amps 750w	10,130 lumens	60,780 lumens	14" x 47" x 23" 355 mm x 1,195 mm x 584 mm	87.5" x 52" x 23" 2,225 mm x 1,320 mm x 584 mm	

QUARTZ HALOGEN



AC	LIGHTING	POWER REQUIREMENTS	OUTPUT (PER LIGHT)	TOTAL OUTPUT	HXWXD (NESTED)	HXWXD (UPRIGHT)	WT.
KL475A-FF	FRC Focus 750w	115 or 230V AC 4,800w	19,600 lumens	117,600 lumens	13" x 47" x 25" 330 mm x 1,195 mm x 635 mm	87.5" x 52" x 25" 2,225 mm x 1,320 mm x 635 mm	165 lbs 75 kg
KL450A-LF	Lumenform 500w	115 or 230V AC 3,300w	11,100 lumens	66,600 lumens	12" x 47" x 23" 305 mm x 1,195 mm x 585 mm	87.5" x 52" x 23" 2,225 mm x 1,320 mm x 585 mm	

OPTIONS (SEE PAGE 5 FOR DESCRIPTIONS)



KL SERIES
4
HEAD



OPTIONS (SEE PAGE 5 FOR DESCRIPTIONS)

- BACKLIGHT*
- STROBE*
- CAMERA*
- COLOR
- CONTROLS

* On this DC tower, amperage only allows for one of these options.



LEDs



DC	LIGHTING	POWER REQUIREMENTS	OUTPUT (PER LIGHT)	TOTAL OUTPUT	HXWXD (NESTED)	HXWXD (UPRIGHT)	WT.
KL415D-FE	FRC Evolution 160w	12V DC - 60 amps 940w	20,000 lumens	80,000 lumens	14" x 47" x 31" 355 mm x 1,195 mm x 787 mm	87.5" x 52" x 31" 2,225 mm x 1,320 mm x 787 mm	165 lbs 75 kg
KL415D-FS	FRC Spectra 220w	12V DC - 84 amps 1,180w	20,000 lumens	80,000 lumens	12" x 47" x 34" 305 mm x 1,195 mm x 865 mm	87.5" x 52" x 34" 2,225 mm x 1,320 mm x 865 mm	
KL415D-FX	FRC Spectra Max 230W	12V DC - 100 amps 1,220w	28,000 lumens	112,000 lumens	12" x 47" x 34" 305 mm x 1,195 mm x 865 mm	87.5" x 52" x 34" 2,225 mm x 1,320 mm x 865 mm	
KL415D-LX	Lightforce HTX LED/HID 150w	12V DC - 60 amps 900w	13,500 lumens	54,000 lumens	14" x 47" x 31" 355 mm x 1,195 mm x 787 mm	87.5" x 52" x 31" 2,225 mm x 1,320 mm x 787 mm	
KL415D-W2	Whelen Pioneer Plus PFH2 150w	12V DC - 63 amps 900w	20,261 lumens	81,044 lumens	12" x 47" x 34" 305 mm x 1,195 mm x 865 mm	87.5" x 52" x 34" 2,225 mm x 1,320 mm x 865 mm	

KL SERIES SLIM

The Knight Slim delivers the Knight Series smallest footprint, stowing flat at just 12" x 13" x 53" thanks to this narrow design, ideal for smaller to mid-size apparatus, or larger trucks with limited space. This compact tower packs a total output of 70,000 lumens thanks to HiViz fixtures.

OPTIONS (SEE PAGE 5 FOR DESCRIPTIONS)

- STROBE*
- CAMERA*
- COLOR
- CONTROLS

* On this DC tower, amperage only allows for one of these options.

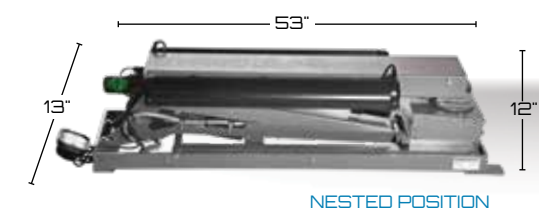

LEDs



AC	LIGHTING	POWER REQUIREMENTS	OUTPUT (PER LIGHT)	TOTAL OUTPUT	HXWXD (NESTED)	HXWXD (UPRIGHT)	WT.
KL409A-H4	(2) HiViz - 270w (2) HiViz - 60w	115V AC - 960w	270w: 28,500 60w: 6,500	70,000 lumens	12" x 13" x 53" 305 mm x 330 mm x 1,346 mm	87.5" x 13" x 53" 2,225 mm x 330 mm x 1,346 mm	165 lbs 75 kg
DC	LIGHTING	POWER	OUTPUT (PER LIGHT)	TOTAL OUTPUT	HXWXD (NESTED)	HXWXD (UPRIGHT)	WT.
KL409D-H4	(2) HiViz - 270w (2) HiViz - 60w	12V DC - 960w	270w: 28,500 60w: 6,500	70,000 lumens	12" x 13" x 53" 305 mm x 330 mm x 1,346 mm	87.5" x 13" x 53" 2,225 mm x 330 mm x 1,346 mm	165 lbs 75 kg

* Knight Slim requires 18" x 7" x 5" electrical box (mounted nearby).

SL SERIES

TOWERS WITH 4.5- TO 10-FOOT REACH

THE SHADOW SERIES are Command Light's most compact units when space is at a premium. These units have a reach of more than 4 feet from its base (or 10' with optional 80" arm), weigh approximately 65 lbs, and are still manufactured using aircraft-grade aluminum alloy for strength. Thanks to this compact size, these units can fit on SUVs, vans and pickup trucks, all the while featuring 355° of rotation.

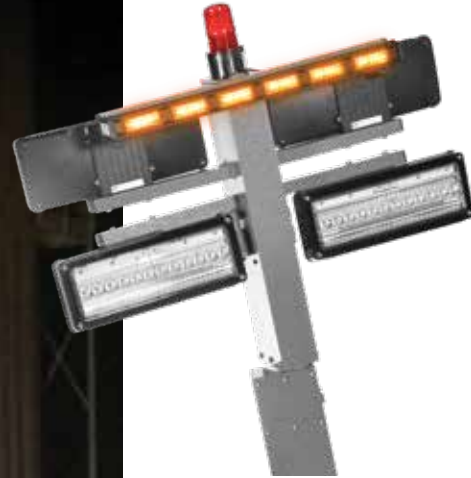

SEE PAGE 18 FOR INFO ON THE ABOVE TRAFFIC LIGHT BAR ADDITION

OPTIONS (SEE PAGE 5 FOR DESCRIPTIONS)



BACKLIGHT



STROBE



COLOR



CAMERA



CONTROLS



LONG ARM

QUESTIONS? CUSTOM TOWER INQUIRIES? CONTACT US AT INFO@COMMANDLIGHT.COM.

LEDs



AC/DC	LIGHTING	POWER REQUIREMENTS	OUTPUT (PER LIGHT)	TOTAL OUTPUT	HXWXD (NESTED)	HXWXD (UPRIGHT)	WT.
SL442A-CH	Helios 60w	12V DC - 115V or 230V AC 420w	14,000 lumens	56,000 lumens	8" x 54" x 34" 205 mm x 1,375 mm x 865 mm	55" x 36" x 34" 1,395 mm x 915 mm x 865 mm	75 lbs 35 kg
SL442A-FS	FRC Spectra 220w	12V DC - 115V or 230V AC 1,060w	20,000 lumens	80,000 lumens	8" x 54" x 34" 205 mm x 1,375 mm x 865 mm	55" x 36" x 34" 1,395 mm x 915 mm x 865 mm	
SL442A-FX	FRC Spectra Max 335w	12V DC - 115V or 230V AC 1,520w	28,000 lumens	112,000 lumens	8" x 54" x 34" 205 mm x 1,375 mm x 865 mm	55" x 36" x 34" 1,395 mm x 915 mm x 865 mm	
SL442A-W1	Whelen PSP1 75w	12V DC - 115V or 230V AC 480w	8,517 lumens	34,068 lumens	8" x 54" x 22" 205 mm x 1,375 mm x 559 mm	55" x 36" x 22" 1,395 mm x 915 mm x 559 mm	
SL442A-W2	Whelen Pioneer Plus PFP2 150w	12V DC - 115V or 230V AC 780w	20,442 lumens	81,768 lumens	8" x 54" x 33" 205 mm x 1,375 mm x 835 mm	55" x 36" x 33" 1,395 mm x 915 mm x 835 mm	
DC	LIGHTING	POWER REQUIREMENTS	OUTPUT (PER LIGHT)	TOTAL OUTPUT	HXWXD (NESTED)	HXWXD (UPRIGHT)	WT.
SL442D-CH	Helios 60w	12V DC - 35 amps 420w	14,000 lumens	56,000 lumens	8" x 54" x 34" 205 mm x 1,375 mm x 865 mm	55" x 36" x 34" 1,395 mm x 915 mm x 865 mm	75 lbs 35 kg
SL442D-FE	FRC Evolution 160w	12V DC - 70 amps 820w	20,000 lumens	80,000 lumens	8" x 54" x 32" 205 mm x 1,375 mm x 815 mm	55" x 36" x 32" 1,395 mm x 915 mm x 815 mm	
SL442D-FS	FRC Spectra 230w	12V DC - 90 amps 1,100w	20,000 lumens	56,000 lumens	8" x 54" x 34" 205 mm x 1,375 mm x 865 mm	55" x 36" x 34" 1,395 mm x 915 mm x 865 mm	
SL442D-FX	FRC Spectra Max 230w	12V DC - 92 amps 1,100 w	28,000 lumens	112,000 lumens	8" x 54" x 34" 205 mm x 1,375 mm x 865 mm	55" x 36" x 34" 1,395 mm x 915 mm x 865 mm	
SL442D-LX	Lightforce HTX LED/HID 150w	12V DC - 60 amps 780w	13,500 lumens	54,000 lumens	8" x 56" x 23" 203 mm x 1,422 mm x 584 mm	57" x 46" x 23" 1,448 mm x 1,169 mm x 584 mm	
SL442D-W1	Whelen Pioneer Plus PCH1 75w	12V DC* - 70 amps 480w	10,130 lumens	40,520 lumens	8" x 54" x 22" 205 mm x 1,375 mm x 559 mm	55" x 36" x 22" 1,395 mm x 915 mm x 559 mm	
SL442D-W2	Whelen Pioneer Plus PPH2 150w	12V DC* - 70 amps 780w	20,261 lumens	81,044 lumens	8" x 54" x 33" 205 mm x 1,375 mm x 835 mm	55" x 36" x 33" 1,395 mm x 915 mm x 835 mm	

QUARTZ HALOGEN

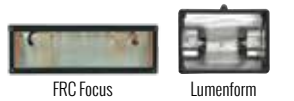

AC/DC	LIGHTING	POWER REQUIREMENTS	OUTPUT (PER LIGHT)	TOTAL OUTPUT	HXWXD (NESTED)	HXWXD (UPRIGHT)	WT.
SL447A-FF	FRC Focus 750w	12V DC - 115V or 230V AC 3,180w	19,600 lumens	78,400 lumens	8" x 54" x 23" 205 mm x 1,375 mm x 585 mm	49.5" x 52" x 23" 1,260 mm x 1,320 mm x 585 mm	70 lbs 32 kg
SL445A-LF	Lumenform 500w	12V DC - 115V or 230V AC 2,180w	11,100 lumens	44,400 lumens	8" x 54" x 22" 205 mm x 1,375 mm x 560 mm	55" x 36" x 22" 1,395 mm x 915 mm x 560 mm	

SL SERIES

TOWERS WITH 4.5-FOOT REACH

HEAD

LEDs

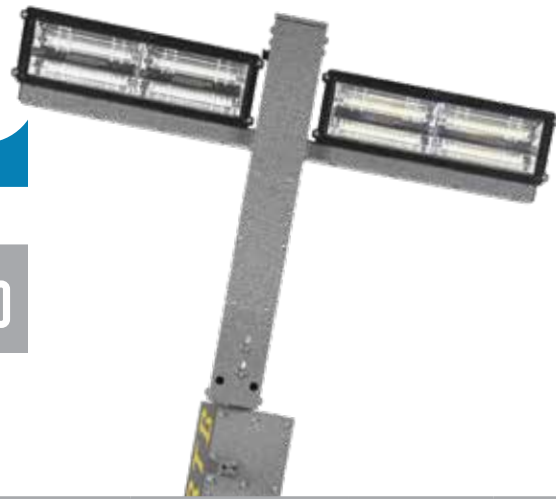

OPTIONS (SEE PAGE 5 FOR DESCRIPTIONS)



AC/DC	LIGHTING	POWER REQUIREMENTS	OUTPUT (PER LIGHT)	TOTAL OUTPUT	HXWXD (NESTED)	HXWXD (UPRIGHT)	WT.
SL422A-CH	Helios 60w	12V DC - 115V or 230V AC 300w	14,000 lumens	28,000 lumens	8" x 54" x 34" 205mm x 1,375 mm x 865 mm	55" x 36" x 34" 1,395 mm x 915 mm x 865 mm	70 lbs 32 kg
SL422A-FS	FRC Spectra 220w	12V DC - 115V or 230V AC 620w	20,000 lumens	40,000 lumens	8" x 54" x 34" 205mm x 1,375 mm x 865 mm	55" x 36" x 34" 1,395 mm x 915 mm x 865 mm	
SL422A-FX	FRC Spectra Max 335w	12V DC - 115V or 230V AC 850w	28,000 lumens	56,000 lumens	8" x 54" x 34" 205mm x 1,375 mm x 865 mm	55" x 36" x 34" 1,395 mm x 915 mm x 865 mm	
SL422A-W2	Whelen Pioneer Plus PFP2 150w	12V DC - 115V or 230V AC 480w	20,442 lumens	40,884 lumens	8" x 54" x 33" 205mm x 1,375 mm x 840 mm	55" x 36" x 33" 1,395 mm x 915 mm x 840 mm	
DC	LIGHTING	POWER	OUTPUT (PER LIGHT)	TOTAL OUTPUT	HXWXD (NESTED)	HXWXD (UPRIGHT)	WT.
SL422D-FE	FRC Evolution 160w	12V DC - 35 amps 500w	20,000 lumens	40,000 lumens	8" x 54" x 32" 205 mm x 1,375 mm x 815 mm	55" x 36" x 32" 1,395 mm x 915 mm x 815 mm	65 lbs 30 kg
SL422D-FS	FRC Spectra 230w	12V DC - 42 amps 620w	20,000 lumens	40,000 lumens	8" x 54" x 34" 205 mm x 1,375 mm x 865 mm	55" x 36" x 34" 1,395 mm x 915 mm x 865 mm	
SL422D-FX	FRC Spectra Max 335w	115V or 230V AC 670w	28,000 lumens	56,000 lumens	8" x 54" x 34" 205mm x 1,375 mm x 865 mm	55" x 36" x 34" 1,395 mm x 915 mm x 865 mm	
SL422D-W1	Whelen Pioneer Plus PCH1 75w	12V DC* - 20 amps 330w	10,130 lumens	20,260 lumens	8" x 54" x 22" 205 mm x 1,375 mm x 560 mm	55" x 36" x 22" 1,395 mm x 915 mm x 560 mm	
SL422D-W2	Whelen Pioneer Plus PFH2 150w	12V DC* - 35 amps 480w	20,261 lumens	40,522 lumens	8" x 54" x 33" 205 mm x 1,375 mm x 840 mm	55" x 36" x 33" 1,395 mm x 915 mm x 840 mm	

NESTED POSITION



Hubbell Quartzlizer

QUARTZ HALOGEN

AC	LIGHTING	POWER REQUIREMENTS	OUTPUT (PER LIGHT)	TOTAL OUTPUT	HXWXD (NESTED)	HXWXD (UPRIGHT)	WT.
SL428A-HQ	Hubbell Quartzlizer 1,000w	230V AC 2,180w	21,500 lumens	43,000 lumens	8" x 54" x 32" 205 mm x 1,375 mm x 815 mm	55" x 36" x 32" 1,395 mm x 915 mm x 815 mm	65 lbs 30 kg
SL429A-HQ	Hubbell Quartzlizer 1,500w	230V AC 3,180w	35,800 lumens	71,600 lumens	8" x 54" x 32" 205 mm x 1,375 mm x 815 mm	55" x 36" x 32" 1,395 mm x 915 mm x 815 mm	

TOWERS WITH 3.5-FOOT REACH

STRAIGHT SHADOW

The Straight Shadow is Command Light's most economical solution in maintaining efficient scene lighting. Featuring only elevated capabilities (and not rotation), this unit offers a 3.5' reach from its base. The Straight Shadow can also be easily modified to elevate cameras and antennas.

OPTIONS (SEE PAGE 5 FOR DESCRIPTIONS)



LEDs

AC/DC	LIGHTING	POWER REQUIREMENTS	OUTPUT (PER LIGHT)	TOTAL OUTPUT	HXWXD (NESTED)	HXWXD (UPRIGHT)	WT.
SS322A-CH	(2) Helios 60w	12V DC - 115V or 230V AC 240w	14,000 lumens	28,000 lumens	9" x 42" x 30" 230 mm x 1,065 mm x 762 mm	42.5" x 45" x 30" 1,080 mm x 1,143 mm x 762 mm	45 lbs 20 kg
SS322A-W2	(2) Whelen PFP2 150w	12V DC - 115V or 230V AC 400w	20,442 lumens	40,884 lumens	9" x 42" x 30" 230 mm x 1,065 mm x 762 mm	42.5" x 45" x 30" 1,080 mm x 1,143 mm x 762 mm	
DC	LIGHTING	POWER REQUIREMENTS	OUTPUT (PER LIGHT)	TOTAL OUTPUT	HXWXD (NESTED)	HXWXD (UPRIGHT)	WT.
SS322D-CH	(2) Helios 60w	12V DC - 20 amps 240w	14,000 lumens	28,000 lumens	9" x 42" x 30" 230 mm x 1,065 mm x 762 mm	43" x 45" x 30" 1,092 mm x 1,143 mm x 762 mm	45 lbs 20 kg
SS322D-W2	(2) Whelen Pioneer Plus PFH2 - 150w	12V DC - 34 amps 420w	20,261 lumens	40,522 lumens	8" x 42" x 30" 205 mm x 1,067 mm x 760 mm	43" x 45" x 30" 1,092 mm x 1,143 mm x 760 mm	

QUARTZ HALOGEN

AC/DC	LIGHTING	POWER	OUTPUT (PER LIGHT)	TOTAL OUTPUT	HXWXD (NESTED)	HXWXD (UPRIGHT)	WT.
SS335A-LF	(3) Lumenform 500w	12V DC - 115V or 230V AC 1,620w	11,100 lumens	33,300 lumens	9" x 42" x 26" 230 mm x 1,065 mm x 660 mm	42.5" x 44.75" x 26" 1,080 mm x 1,135 mm x 660 mm	40 lbs 18 kg
SS345A-LF	(4) Lumenform 500w	12V DC - 115V or 230V AC 2,120w	11,100 lumens	44,400 lumens	8" x 42" x 25" 205 mm x 1,065 mm x 635 mm	44" x 44.75" x 25" 1,120 mm x 1,135 mm x 635 mm	45 lbs 20 kg

Lumenform



AVAILABLE IN 2-, 3- AND 4-HEAD CONFIGURATIONS

C-LITE

COMPACT LIGHTING



THE C-LITE is a versatile, compact unit that boasts a LED spotlight/floodlight combo, creating a concentrated beam that allows the operator to illuminate areas not typically reached by fixed lights. The C-Lite has the ability to tilt up to 120° and even rotate with an optional platform. This unit's small, lightweight design can be mounted vertically or horizontally, perfect for aerial tip illumination, command vehicle lighting and utility industry applications, like farming, ranching, towing, maintenance and more. This light is also a favorite among law enforcement.

OPTIONS (SEE PAGE 5 FOR DESCRIPTIONS)

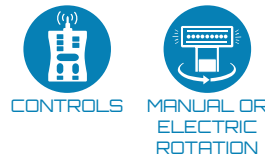

LEDs

DC	LIGHTING	POWER REQUIREMENTS	OUTPUT (PER LIGHT)	TOTAL OUTPUT	HXWXD (NESTED)	HXWXD (UPRIGHT)	WT.
CD113D-FS	(1) FRC Spectra 220w	12V DC - 19 amps 300w	20,000 lumens	20,000 lumens	9" x 14" x 19" 229 mm x 355 mm x 483 mm	21" x 14" x 19" 533 mm x 355 mm x 483 mm	30 lbs 14 kg
CD128D-FN	(2) FRC Mini Spectra 130w	12V DC - 19 amps 240w	14,000 lumens	28,000 lumens	9" x 19" x 19" 229 mm x 483 mm x 470 mm	21" x 26" x 19" 533 mm x 660 mm x 470 mm	
CD127D-W1	(2) Whelen Pioneer Plus PCH1 75w	12V DC - 19 amps 230w	10,130 lumens	20,260 lumens	9" x 19" x 19" 229 mm x 483 mm x 470 mm	21" x 19" x 19" 508 mm x 482 mm x 482 mm	

COLLISION AVOIDANCE



L-CAS The Laser Collision Avoidance System (L-CAS), brought to you by Command Light and Real Fire Tools, is a heads-up display that helps aerial operators avoid collision when approaching a structure with an aerial ladder. This intuitive system uses three laser beams to indicate distance. As the ladder approaches the building, the beams move closer together to give precise measurements. (When using the L-CAS in tests, operators were accurate within 4 inches, even when ladders were extended to distances of 80-100 feet.)

WORKS WITH MULTIPLE AERIAL MOVEMENTS

- Ladder extension
- Apparatus booming
- Aerial rotation
- Combination of all three

OPTIONAL Stainless-Steel Armour protects the L-CAS from bumps, drops, etc.

Z-LIFT

LIGHT BAR ELEVATION



THE Z-LIFT Improve visibility by elevating your vehicle's warning lights above the roofline with Command Light's Z-Lift. This lift includes an umbilical remote with auto-deploy and auto-park feature. With the press of a button, the lift can be auto-deployed to be square or rotated 45° or 90° to save time.

- Elevates 40" in 10 seconds
- Rotates 90° (left and right), allowing the lightbar to positioned toward oncoming traffic



DC	POWER REQUIREMENTS	HXWXD (NESTED)	HXWXD (UPRIGHT)	WT.
Z-LIFT	12V DC - 16.5 amps 200w	6" x 22" x 47" 155 mm x 560 mm x 1,195 mm	43" x 22" x 75" 1,092 mm x 560 mm x 1,905 mm	62 lbs 28 kg



See the Z-Lift in action at commandlight.com/z-lift.

GONE ARE THE DAYS OF RELYING ON AERIAL SPOTTERS, whose time could be better spent performing other essential operations.

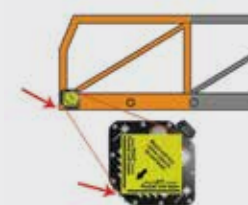

DC	LASERS	WEIGHT	POWER
LC130	(3) Class III	2 lbs. (6 lbs. with armour)	12V DC - 1.7 amps 20w

The L-CAS also increases accuracy when laddering a roof. When the ladder is dangerously overhanging the building, the L-CAS beams disappear, indicating that the tip of the ladder has crossed the roof's edge.



CHOOSING A FLOWBOARD

1 SELECT THE FLOW BOARD PROFILE

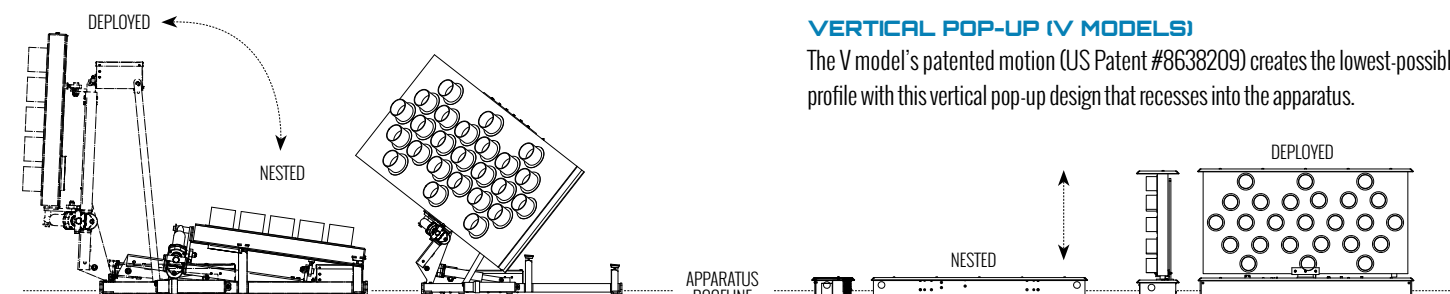

VERTICAL POP-UP (V MODELS)

The V model's patented motion (US Patent #8638209) creates the lowest-possible profile with this vertical pop-up design that recesses into the apparatus.

FOLD-DOWN DESIGN (H MODELS)

The H Model features a fold-down design that mounts to the apparatus to create a low-profile. Once deployed, the flow board can be rotated toward oncoming traffic.



2 SELECT A TRAFFIC PATTERN

TRAFFIC FLOW BOARDS With rotational capabilities and multiple arrow patterns, Command Light's Traffic Flow Boards significantly improve on-scene visibility and responder safety. Available in six different models (based on deployment and traffic pattern features), these units conserve space when stowed, while the versatile mounting system gives crews the ability to select various boards to conform to department requirements. Each model comes with standard rotation, giving crews the ability to position traffic advisory arrows toward traffic to maximize effectiveness during blocking modes.

DC	MOVEMENT	TRAFFIC PATTERN	POWER REQUIREMENTS	HXWXD (NESTED)	HXWXD (UPRIGHT)	WT.
TFB-V7	Vertical pop-up, recessed in apparatus	Greatest variety of traffic patterns	12V DC - 7 amps	43" x 64" x 13" 1,092 mm x 1,626 mm x 330 mm	75" x 64" x 13" 1,905 mm x 1,626 mm x 330 mm	220 lbs 100 kg
TFB-H7	Fold-down design	Greatest variety of traffic patterns	12V DC - 5 amps	16" x 60" x 46" 406 mm x 1,524 mm x 1,168 mm	44" x 60" x 66" 1,118 mm x 1,524 mm x 1,676 mm	150 lbs 68 kg
TFB-V5	Vertical pop-up, recessed in apparatus	Essential traffic patterns	12V DC - 5 amps	28" x 44" x 13" 711 mm x 1,118 mm x 330 mm	43" x 44" x 13" 1,092 mm x 1,118 mm x 330 mm	150 lbs 68 kg
TFB-H5	Fold-down design	Essential traffic patterns	12V DC - 5 amps	8" x 48" x 40" 203 mm x 1,219 mm x 1,106 mm	52" x 70" x 40" 1,321 mm x 1,778 mm x 1,016 mm	80 lbs 36 kg
TFB-CL5	Fold-down design, mounted to a CL Series tower	Essential traffic patterns	12V DC - 5 amps + tower requirements	Variable based on tower selection	Variable based on tower selection	28 lbs + tower
TFB-SL3	Fold-down design, mounted to a Shadow Series tower	Directional light bar	12V DC - 5 amps + tower requirements	Variable based on tower selection	Variable based on tower selection	14 lbs + tower



7 SERIES

The 7 Series offers the greatest variety of traffic patterns and can be deployed via the fold-down design or the vertical pop-up design.



5 SERIES

The 5 Series offers essential traffic patterns in a lighter design. The board can be deployed via the fold-down design or the vertical pop-up design.



3 SERIES

The 3 Series features a light bar that provides a pulsing movement to guide traffic. The light bar mounts to the top of a SL Series light tower.





COMMAND LIGHT

COMMANDLIGHT.COM.COM | 800.797.7974 | 3842 REDMAN DR. FORT COLLINS CO 80524

See a Command Light representative or authorized dealer for details. All information in this brochure is the latest available at the time of publication. Printed in the USA. 2.5K 1019 ©2019 Command Light