

COMMAND LIGHT



Effective November 2016
This guide supersedes all previous versions

Wireless

3842 Redman Drive
Fort Collins, CO 80524

1-800-797-7974
www.CommandLight.com

THANK YOU

Please allow us to express a simple thank you for investing in a *COMMAND LIGHT* product. As a company we are dedicated to producing the very best and most versatile flood lighting package available. We take great pride in the quality of our work and hope that you will find many years of satisfaction from the use of this equipment.

Should you have any problems with your product please do not hesitate to contact us.

COMMAND LIGHT

3842 Redman Drive
Fort Collins, CO 80524

PHONE: 1-800-797-7974
FAX: 1-970-297-7099
WEB: www.CommandLight.com



DANGER

PERSONAL RESPONSIBILITY CODE

The member companies of FEMSA that provide emergency response equipment and services want responders to know and understand the following:

1. Firefighting and Emergency Response are inherently dangerous activities requiring proper training in their hazards and the use of extreme caution at all times.
2. It is your responsibility to read and understand any user's instructions, including purpose and limitations, provided with any piece of equipment you may be called upon to use.
3. It is your responsibility to know that you have been properly trained in Firefighting and/or Emergency Response and in the use, precautions, and care of any equipment you may be called upon to use.
4. It is your responsibility to be in proper physical condition and to maintain the personal skill level required to operate any equipment you may be called upon to use.
5. It is your responsibility to know that your equipment is in operable condition and has been maintained in accordance with the manufacturer's instructions.
6. Failure to follow these guidelines may result in death, burns or other severe injury.



Fire and Emergency Manufacturers and Services Association, Inc.
P.O. Box 147, Lynnfield, MA 01940 www.FEMSA.org

Copyright 2006 FEMSA. All Rights Reserved

Please take the time to read this manual before installing or operating the *C-Lite*.

Save this guide for future reference.

Contents

LIMITED WARRANTY 5

Breakage or Damage During Shipment 6

General Description and Specifications 7

Electrical Wiring 7

Installation 7

 Included Parts 7

 Tools Required 7

Maintenance 8

 Cleaning 8

Troubleshooting 8

Wireless Option 8

 Replacing Battery 8

Options 8

 Manual Rotation Base 9

 Electric Rotation Base 9

Technical Specifications 10

 Manual Rotation 10

 Electric Rotation 11

Parts List – Exploded View 11

Wiring Diagram 13



Command Light
3842 Redman Drive
Fort Collins, CO 80524

PHONE: 1-800-797-7974
FAX: 1-970-297-7099
WEB: www.CommandLight.com

LIMITED WARRANTY

Five Years

COMMAND LIGHT warrants that the equipment is free from defects in materials and workmanship when used and operated for a period of five years. The responsibility of *COMMAND LIGHT* under this limited warranty is limited to the repair and replacement of any parts found defective. Parts must be returned to *COMMAND LIGHT* at 3842 Redman Drive, Ft Collins, Colorado 80524 with transportation charges prepaid (**C.O.D. shipments will not be accepted**).

Prior to returning defective parts to *COMMAND LIGHT*, the original purchaser shall make a claim in writing to *COMMAND LIGHT* at the above address indicating the model number, serial number and type of defect. No parts or equipment will be received by *COMMAND LIGHT* for repair or replacement under this warranty without specific written authority from it in advance.

Any parts damaged by improper installation, overloading, abuse or accident of any type or cause are not covered by this warranty.

All equipment manufactured by us is tested before leaving our plant, and is shipped in good working order and condition. We therefore extend to the original purchasers the following Limited Warranty for the period of five years from the original date of purchase:

1. This warranty does not apply to defects caused by accident, misuse, neglect, or wear and tear, nor can we be held responsible for incidental and consequential expense and loss, nor does this warranty apply to equipment where alterations have been executed without our knowledge or consent. These conditions are readily discernable when the equipment is returned to us for inspection.
2. On all component parts not manufactured by *COMMAND LIGHT*, their warranty is to the extent that the manufacturer of such component warrants them to *COMMAND LIGHT*, if at all. Look in your local business telephone directory for the nearest repair station for the brand of parts you have or write to us for the address.
3. If equipment received has been damaged in transit, a claim should be made against the carrier within three days, as we assume no responsibility for such damage.
4. Any service other than our Authorized Service voids this warranty.
5. This warranty is in lieu of and is intended to exclude all other warranties, express or implied, oral or written, including any warranties of MERCHANTIBILITY or FITNESS for a particular purpose.
6. Travel time paid at a maximum of 50% and only if pre-approved.

Breakage or Damage During Shipment

The transportation company is fully responsible for all shipping damage and will resolve problems promptly if you handle it correctly. Please read these instructions carefully.

Examine the contents of all shipping cases. If you find any damage, call your transportation agent at once and have them make a description on the freight or express bill describing the damage and the number of pieces. Then contact us and we will send you the original bill of lading. Also promptly contact the transportation company and follow their procedure for filing a claim. Each company will have a unique procedure to follow.

Please note, we cannot and will not enter claims for damages. If we filed claim here, it would be sent to your local freight agent for verification and investigation. This time can be saved by you filing the claim directly. Every consignee is on the ground floor, in contact with the local agent who inspects the damaged goods, and thus, each claim can be given individual attention.

Since our goods are packed to comply with the regulations of all railroad, truck, and express companies, we cannot allow deduction from any invoice because of any damage, however, be sure to file your claim promptly. Our goods are sold F.O.B. factory. We take receipt from the transportation company certifying that the goods were delivered to them in good order and our responsibility ceases.

It is seldom that any breakage or damage occurs in any of our shipments and in no case will the customer be out any expense if they follow the above instructions.

Be sure to keep all damaged goods subject to examination of the truck or express company inspector, who may call on you some time later. These damaged goods, of course, will belong to them, and they will inform you what to do with them. If you dispose of these damaged goods, your claim may not be paid.

General Description and Specifications

Optimal Operating Voltage	12VDC
Acceptable Operating Voltage	11-13VDC
Max Amp Draw	17.5 Amp

Electrical Wiring

The *C-Lite* is provided with 25 feet of 12AWG-2 Conductor Cable color coded with red and black wires. Provide a 12VDC+ signal on the red wire and a 12VDC Ground signal on the black wire to power the *C-Lite*. Reversing these wires may cause damage to the internal circuitry or components of the *C-Lite*.

A 20 amp fuse is recommended to protect the *C-Lite* from electrical damage.

Installation

The *C-Lite* must be installed by a designated installation facility by qualified personnel only. All safety precautions must be thoroughly understood before installation. Please consult the factory for additional installation information assistance.

Included Parts

- Four (4) – ¼-20 x 1” Hex Head Bolt
- Eight (8) – ¼” Flat Washer
- Four (4) – ¼-20 Nyloc Nut
- One (1) – ½” Straight Sealcon with Nut
- One (1) – Command Light Screwdriver
- One (1) – User Guide

Tools Required

- 7/16” Wrench and Socket
- Drill with assorted bits

Maintenance

Cleaning

The *C-Lite* is constructed with corrosion resistant aluminum and stainless steel fasteners. To further enhance corrosion resistance all exposed surfaces receive a powder coated paint finish. To assure years of trouble free service periodically clean all external surfaces with a mild detergent solution and a gentle spray of water. **DO NOT USE A HIGH-PRESSURE WASHER**, which will force water into sensitive electric circuitry.

Troubleshooting

If the *C-Lite* stops operating, disconnect and reconnect power. If operation does not resume, test for a valid 12VDC power source and ground. If this does not remedy the issue, contact Command Light at 1-800-797-7974 for Technical Support.

Wireless Option

Replacing Battery

The wireless controller for the *C-Lite* is powered with a **CR2032** button style battery. Follow these steps to replace the controller battery:

1. Remove red cover grip from the controller by stretching the bottom portion around the back and sliding it towards the antenna.
2. Open the wireless controller by loosening the 4 screws located on the back of the controller.
3. Slide the old battery out of the retainer clip on the transmitter circuit board being careful to not press the “Code Set” button located above the battery.
4. Slide the new battery into the retainer clip with the + Side Up.

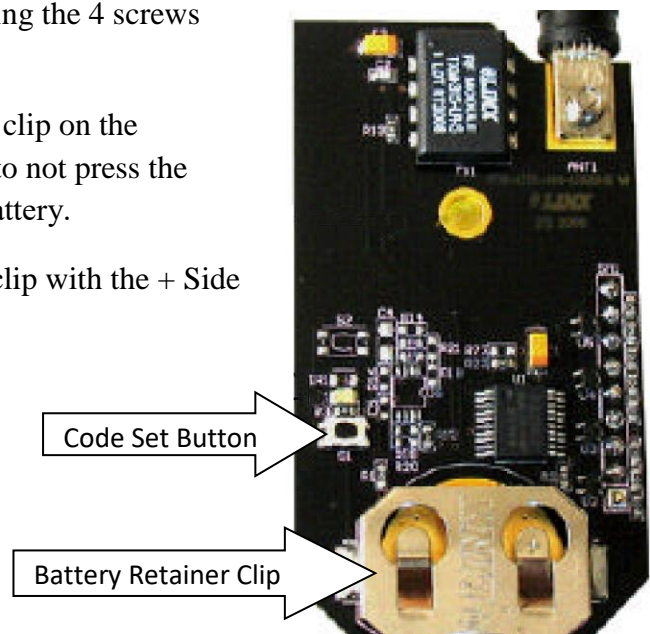

Options

Manual Rotation Base

If the *C-Lite* was ordered with the Manual Rotation Base option, it comes pre-installed. Mounting hole pattern of the Manual Rotation Base is the same as the *C-Lite*. This option adds 2 inches to the overall height of the *C-Lite*.

Electric Rotation Base

If the *C-Lite* was ordered with the Electric Rotation Base option, it comes pre-installed. Mounting hole pattern of the Electric Rotation Base is the same as the *C-Lite*. This option adds 3 inches to the overall height of the *C-Lite*.

Technical Specifications

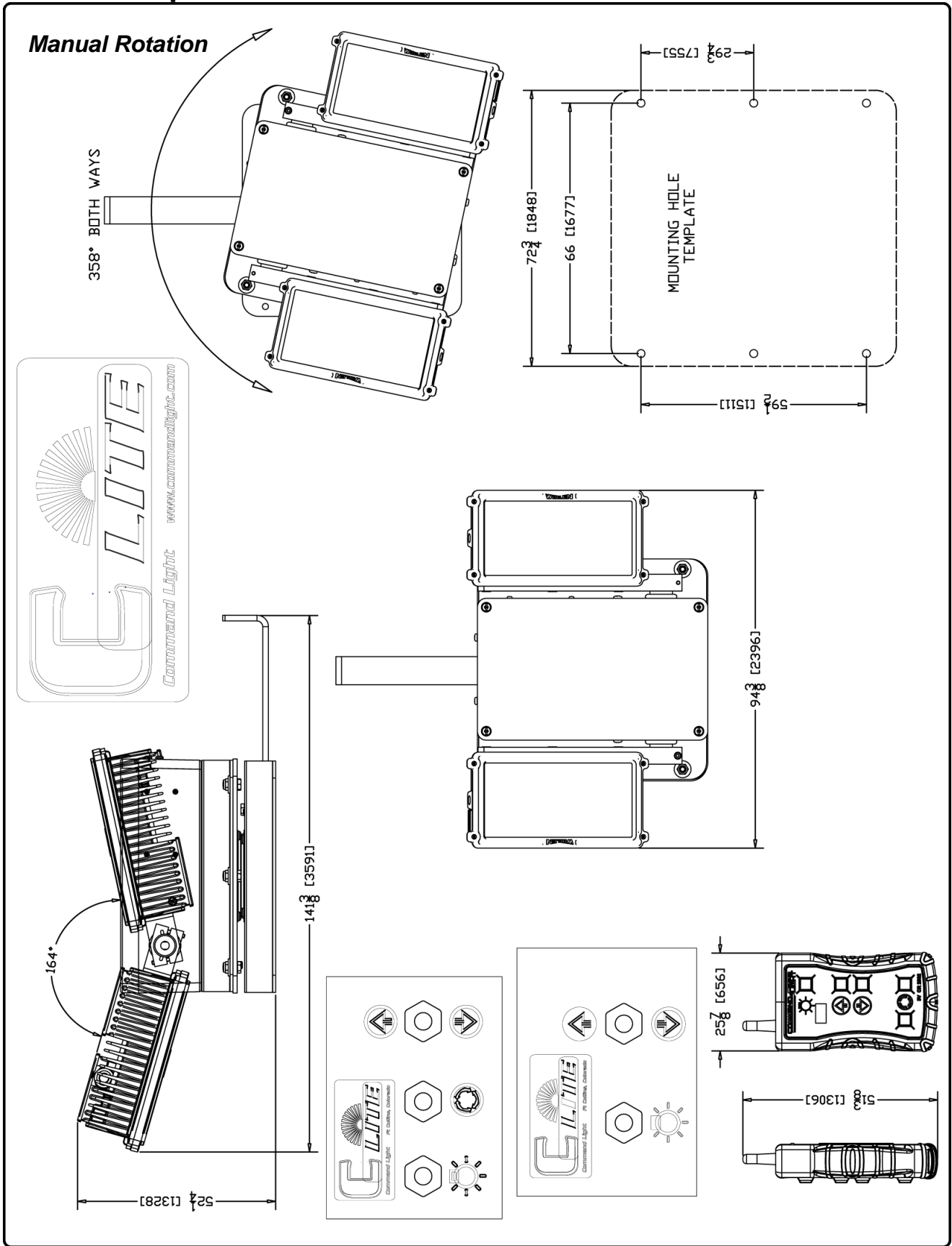

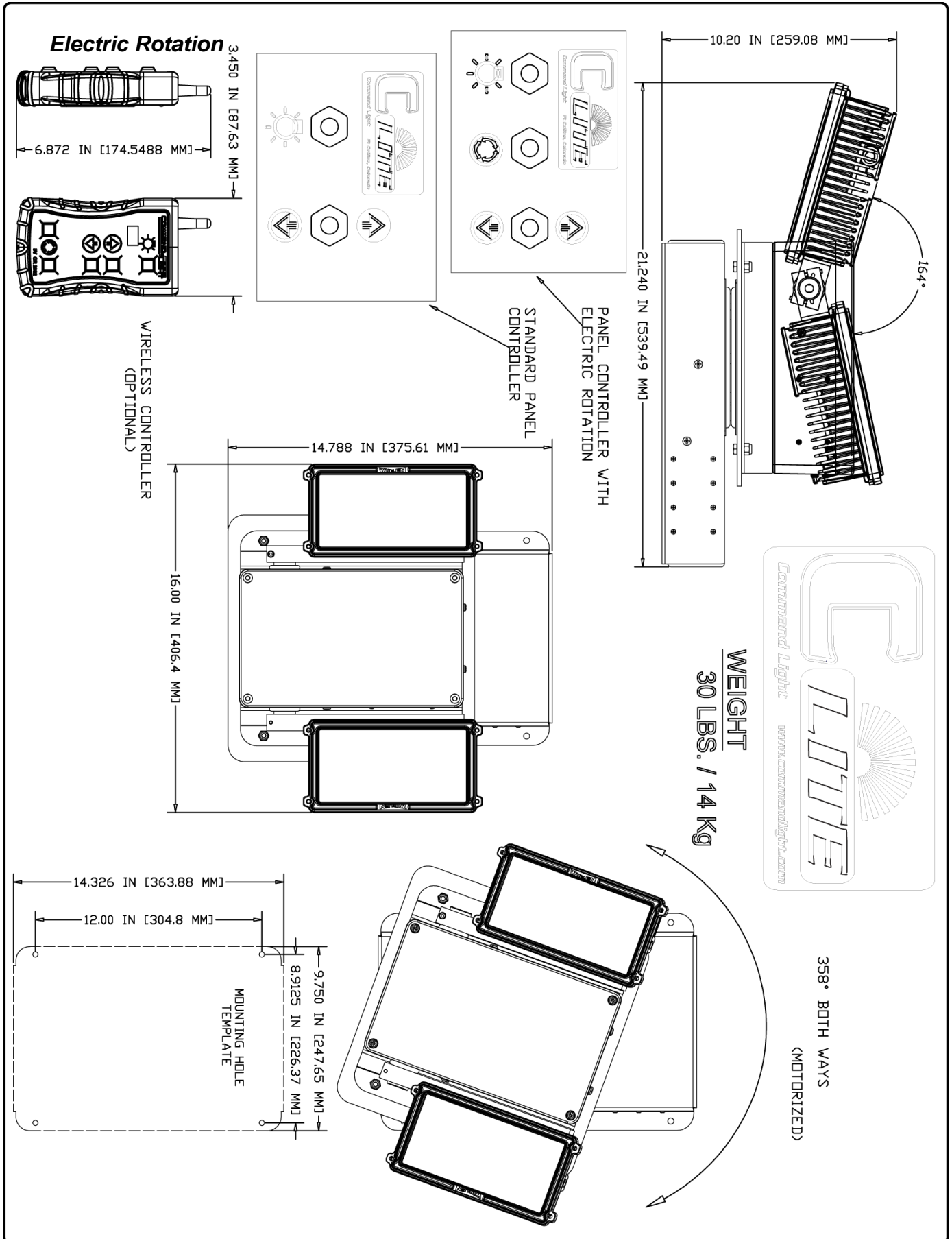

Parts List – Exploded View

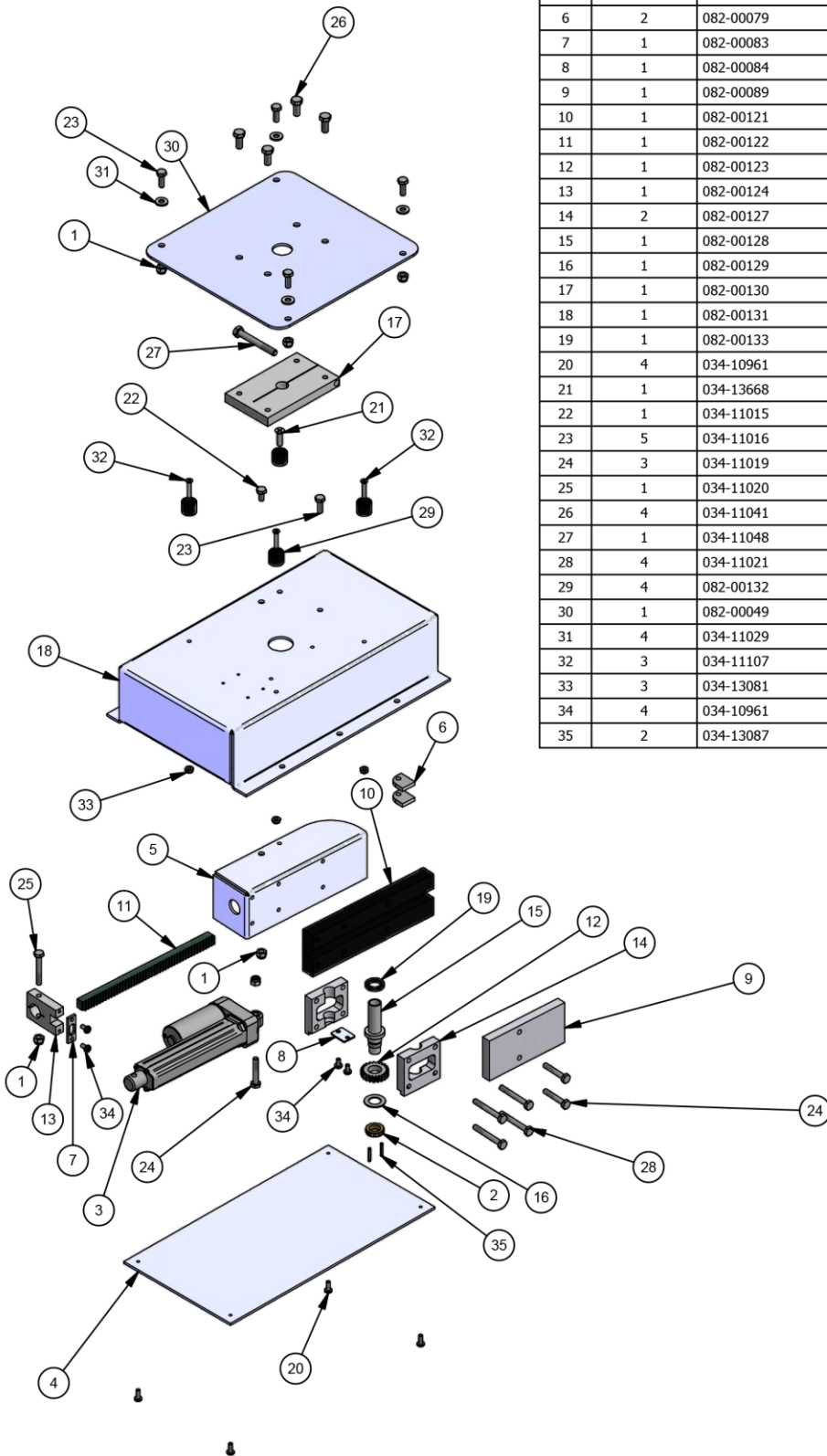

PARTS LIST			
ITEM	QTY	PART NUMBER	DESCRIPTION
1	7	034-11033	NUT,NYLOCK, 1/4-20 UNC,SS
2	1	070-00414	NUT,CLUTCH, CLXXX
3	1	082-00074	ACTUATOR,12V,1000 NEWTON,100mm C-LITE
4	1	082-00076	COVER,ENCLOSURE, ELECT ROTATION
5	1	082-00078	INSERT, ACTUATOR ROTATION
6	2	082-00079	BLOCK, ACTUATOR
7	1	082-00083	CAP,ACTUATOR TRAVEL BLOCK
8	1	082-00084	CLAMP,CABLE
9	1	082-00089	SLIDE, TOP BLOCK
10	1	082-00121	SLIDE,RACK HYBRID
11	1	082-00122	RACK,TRAVEL
12	1	082-00123	GEAR,SHAFT
13	1	082-00124	BLOCK,ACTUATOR TRAVEL
14	2	082-00127	BLOCK,BEARING
15	1	082-00128	DRIVE, SHAFT
16	1	082-00129	GASKET, CLUTCH, C-LITE
17	1	082-00130	BLOCK,ROTATION
18	1	082-00131	ENCLOSURE, ELECT ROTATION, C-LITE
19	1	082-00133	SPACER, DRIVE SHAFT, C-LITE
20	4	034-10961	SCREW,PHP,10-24 UNCx0.5
21	1	034-13668	SCREW,FHPMS,1/4-20 UNC x 7/8 in,SS
22	1	034-11015	SCREW,HH,1/4-20x1/2,SS
23	5	034-11016	SCREW,HH,1/4-20x3/4,SS
24	3	034-11019	SCREW,HH,1/4-20x1-1/2,SS
25	1	034-11020	SCREW,HH,1/4-20x1-3/4,SS
26	4	034-11041	SCREW,HH,5/16-18x3/4,SS
27	1	034-11048	SCREW,HH,5/16-18x2-1/2,SS
28	4	034-11021	SCREW,HH,1/4-20x2,SS
29	4	082-00132	SPACER, TILT
30	1	082-00049	PLATE,BASE,ELECT ROTATION
31	4	034-11029	WASHER,FLAT,SAE, 1/4", SS
32	3	034-11107	SCREW,FHPMS,10-24 UNC x 1 in,SS
33	3	034-13081	NUT,NYLOCK,THIN, 10-24 UNC,SS
34	4	034-10961	SCREW,PHP,10-24 UNCx0.375
35	2	034-13087	PIN,SPRING,1/8 x .75

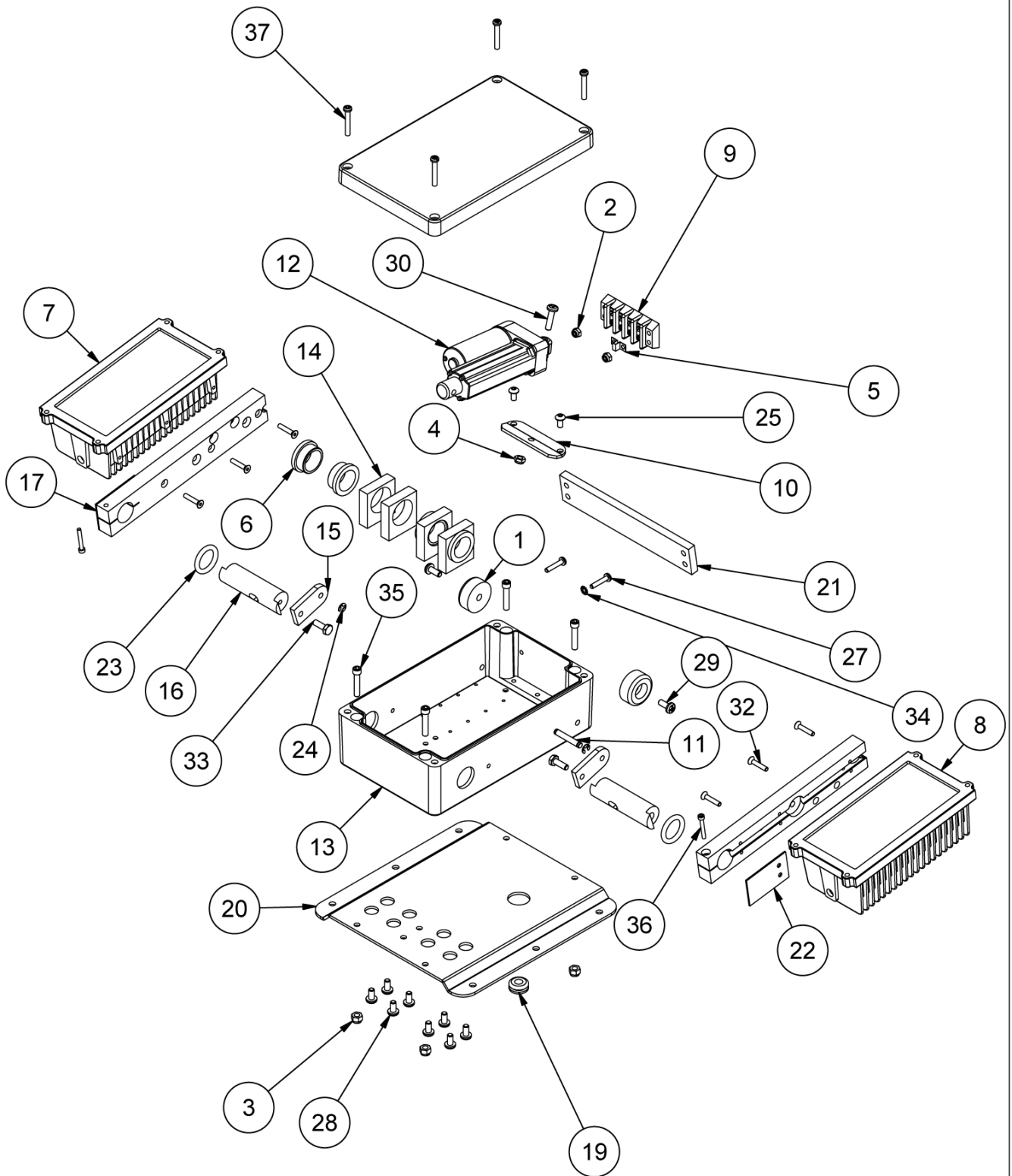

PARTS LIST			
ITEM	QTY	PART NUMBER	DESCRIPTION
1	2	008-11100	FEET, ROUND, 2", BLACK, NANO
2	2	034-10981	NUT,NYLOCK, 10-24 UNC,SS
3	4	034-11033	NUT,NYLOCK, 1/4-20 UNC,SS
4	1	034-11116	NUT,NYLOCK,THIN, 1/4-20 UNC,SS
5	1	065-12315	JUMPER,RELAY BOX
6	4	065-12381	BUSHING,1 IN,FLANGE 1.5,THRML POLY,SRTBL
7	1	065-13999	FIXTURE,LED,75W,12VDC,2 DEGREE,BLK,CLITE
8	1	065-14000	FIXTURE,LED,75W,12VDC,8 DEGREE,BLK,CL
9	1	069-14249	TRW, STRIP, 4 POLE
10	1	082-00054	BRACKET, MOUNT, ACTUATOR, C-LITE
11	1	082-00056	PIN, ROTATION, C-LITE
12	1	082-00059	ACTUATOR,12V,1000 NEWTON,50mm STRK,CLITE
13	1	082-00067	ENCLOSURE,MACHINED,1590Z162BK
14	4	082-00068	BLOCK,BEARING,SHAFT,C LITE
15	2	082-00070	ARM, ROTATOR, C-LITE
16	2	082-00072	SHAFT, ROTATION, C-LITE
17	2	082-00093	ARM,LAMP,C LITE
18	1	082-00094	COVER, LAMP MOUNT, C-LITE
19	1	082-00105	GROMMET,ID.438,OD.938,.438H for .188THIC
20	1	082-00134	MOUNT,ENCLOSURE,C LITE (LOW PROFILE)
21	1	082-00136	MOUNT, DUEL LAMP, C-LITE
22	2	082-00138	COVER, LAMP ARM, C-LITE
23	2	AS568A-318	ORING,ID 0.975,SIZE 0.975,AS568A-318
24	2	SSER-16	E-Ring, X5133-21, .027T, SS
25	2	STD HARDWARE BHM40	SCREW,BH,HEX,6x1x12,SS
26	8	STD HARDWARE--57	SCREW,PHP,10-24 UNCx0.5
27	2	STD HARDWARE--61	SCREW,PHP,10-24 UNCx1
28	8	STD HARDWARE--80	SCREW,PHP,1/4-20 UNCx0.5
29	2	STD HARDWARE--81	SCREW,PHP,1/4-20 UNCx0.625
30	1	STD HARDWARE--84	SCREW,PHP,1/4-20 UNCx1
31	4	STD HARDWARE-FHMS-131	SCREW,FHPMS,1/4-20 UNC x 7/8 in,SS
32	6	STD HARDWARE-FHSH-47	SCREW,FHSH,10-24x1,SS
33	4	STD HARDWARE-HHCS-04	SCREW,HH,1/4-20x3/4,SS
34	1	STD HARDWARE-IEW-69	WASHER,LOCK,18-8SS,EXTERNAL,#10
35	4	STD HARDWARE-SHCS-64	SCREW,SHCS,1/4-20x1-1/4,SS
36	2	STD HARDWARE-SHCSM40	SCREW,SHCS,SHCS M4x0.7x30
37	4	Screw, M6	SCREW,LID,M6, C-LITE

C-LIGHT WITH REMOTE R3

Wiring Diagram

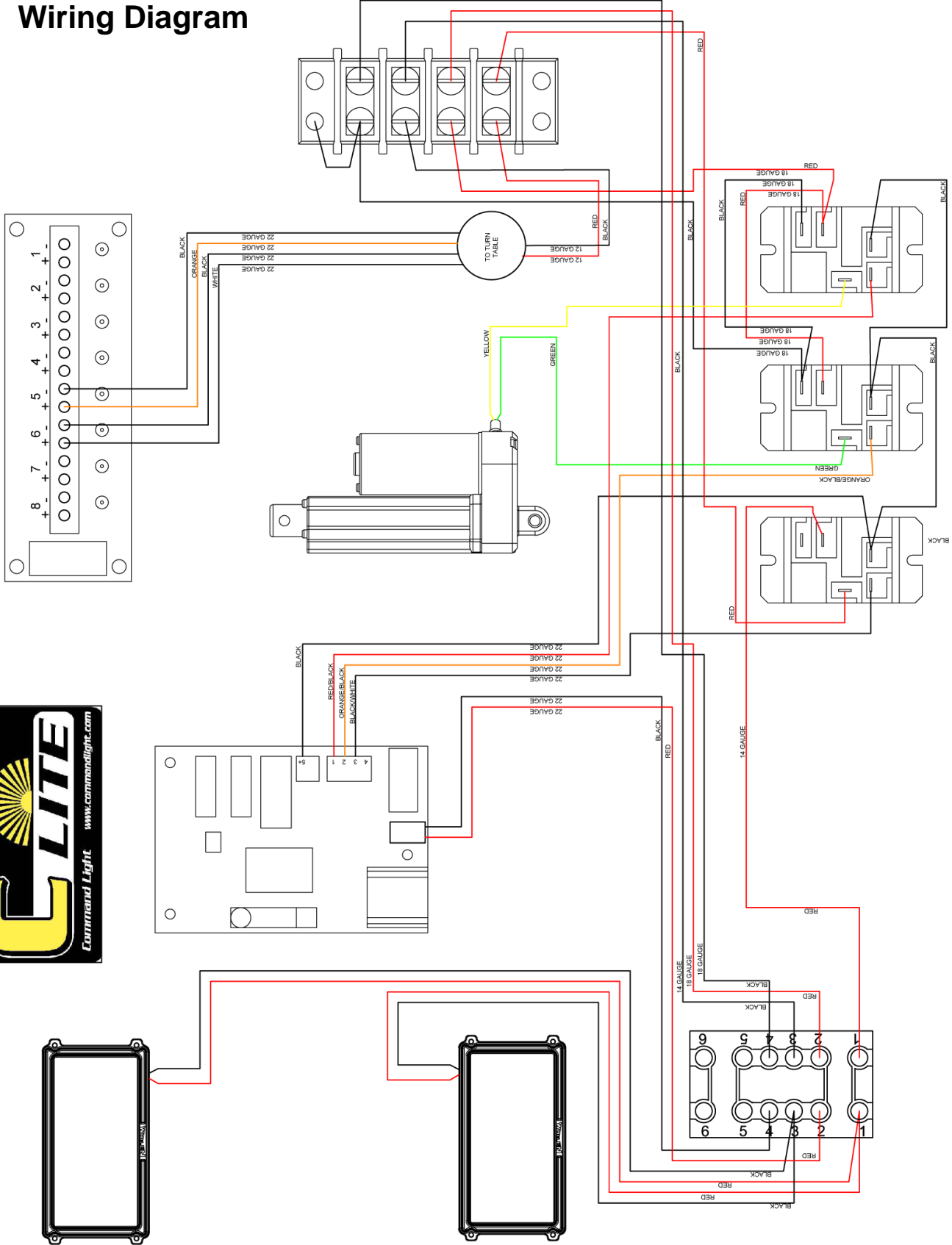

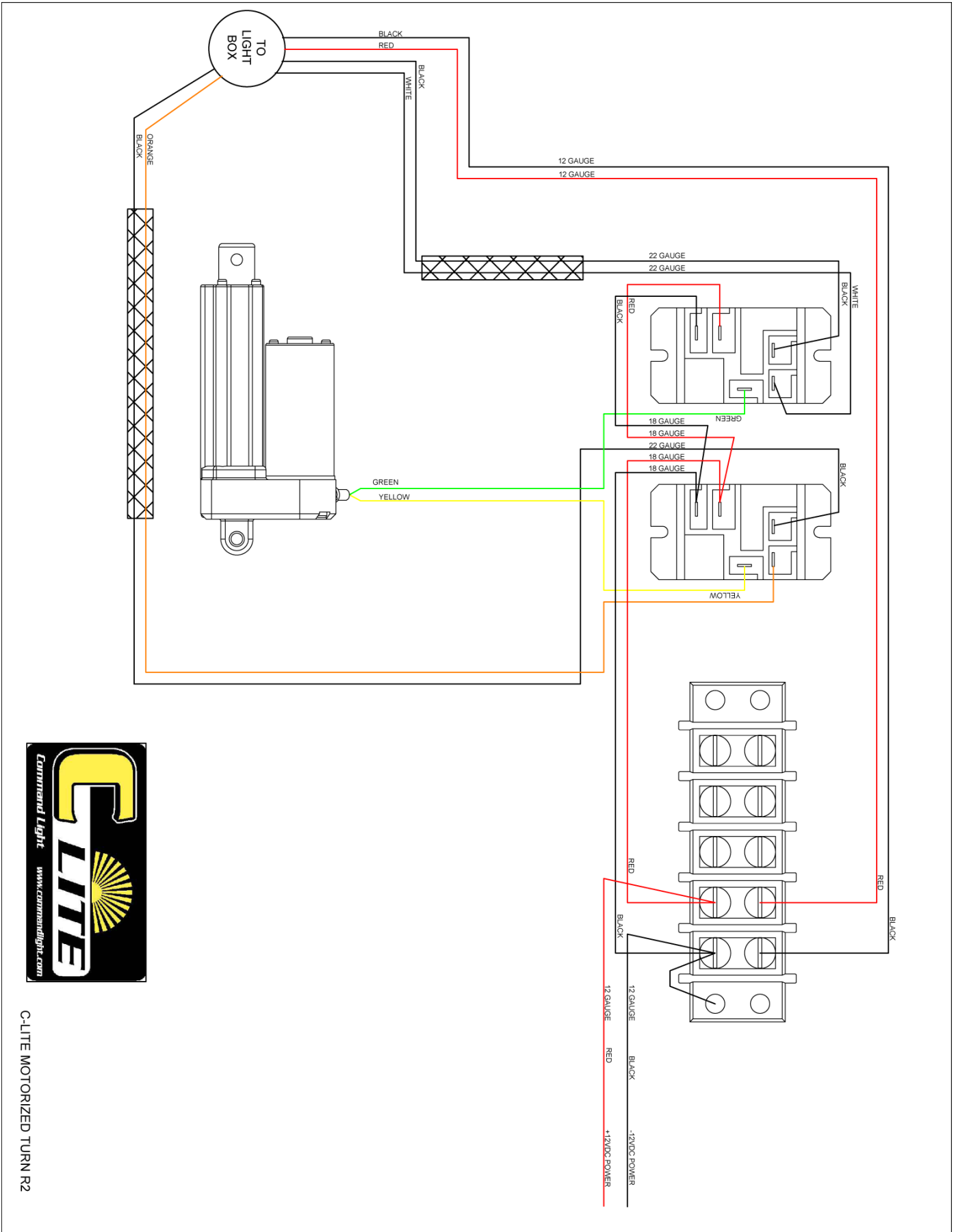

C-LITE MOTORIZED TURN R2